

Parts

Front Profile

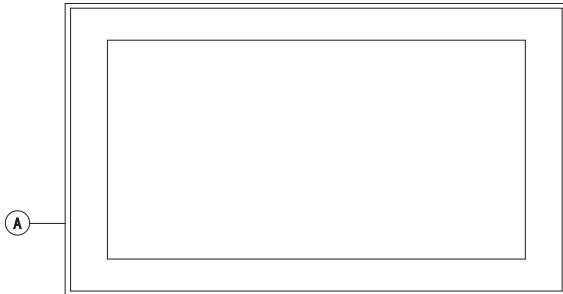

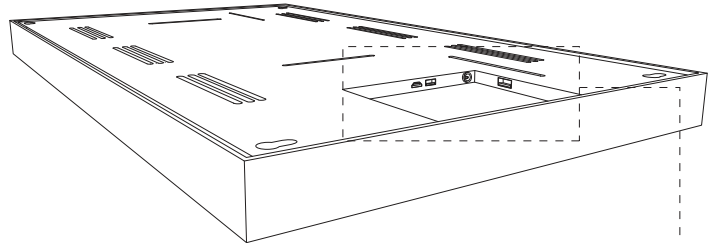



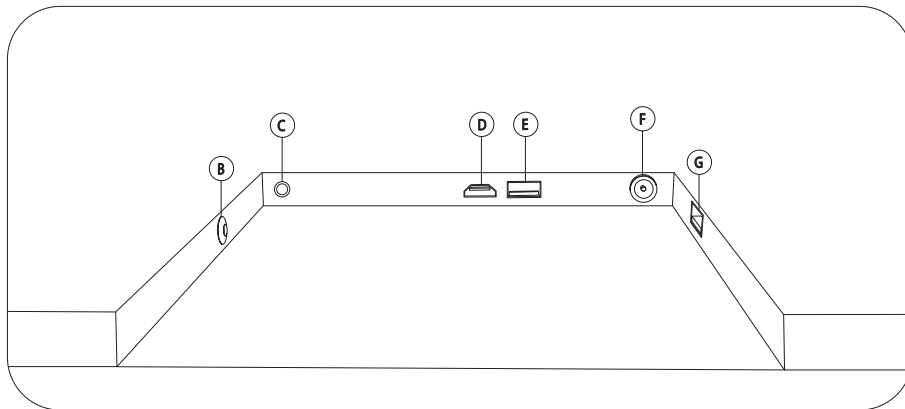

Back Profile



These are the four holes that would secure the spectrum to the bolts installed on the wall.



Note: For your convenience the set top box comes pre-installed at the back of the spectrum. This chart is created to help the user maximize the full benefits of the product and not as a guide for installation.

A		Frame
B		Power Port for Android
C		Audio Port
D		HDMI Port for the Set Top Box
E		USB Port
F		Power Port
G		USB Port

Note:

- Once the spectrum is installed on the wall, the ports at the back will no longer be accessible.
- The Spectrum has built-in speakers.
- The Spectrum is designed to be Gap-free. There will be no space between the T.V. and the wall when it's installed.
- The frame comes in a variety of designs to choose from.
- Spectrum also comes in portrait orientation but only if requested.

Set Top Box

Parts and manual



Front Profile

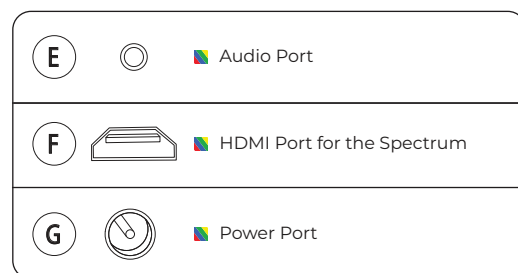
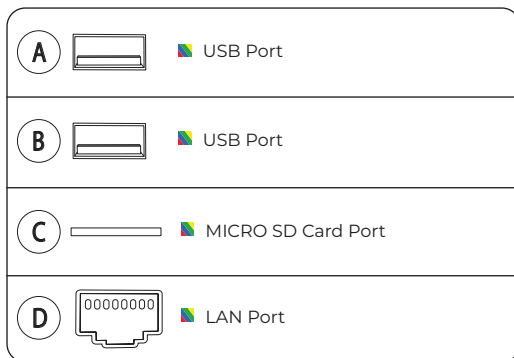
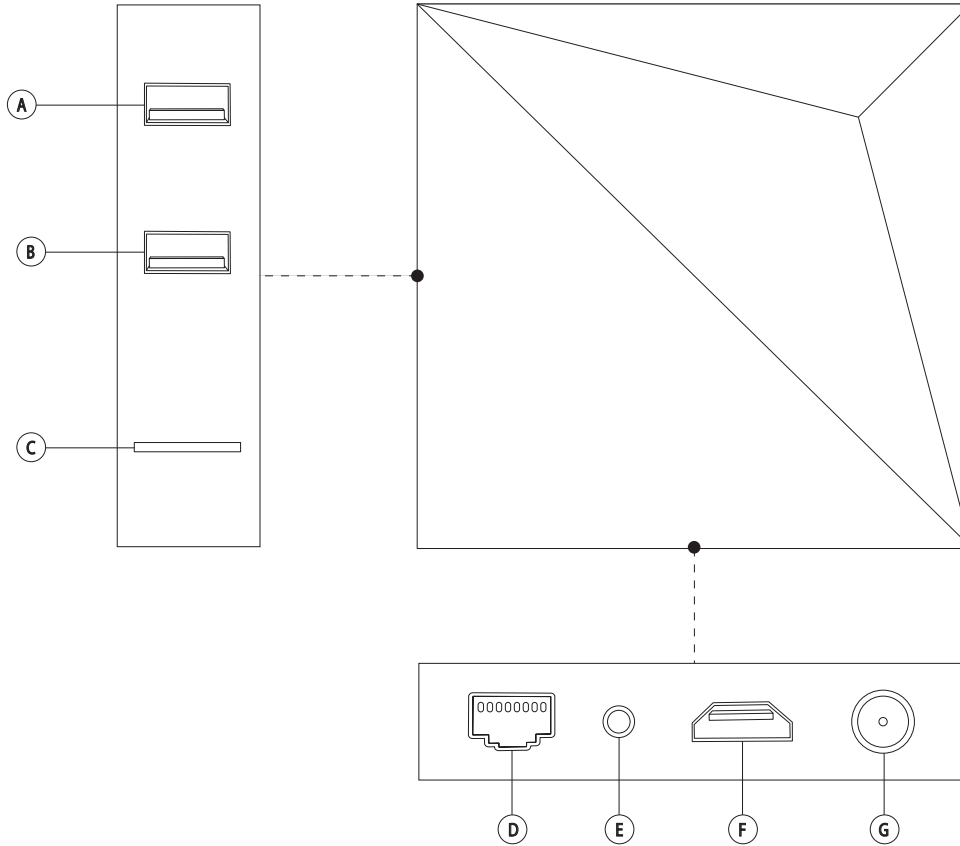

Note: The USB receivers need to be connected to the Set Top Box in order to work.

Once the spectrum is installed on the wall, the ports at the back will no longer be accessible. Attach all the things that need to be attach before hanging the mirror to the wall.

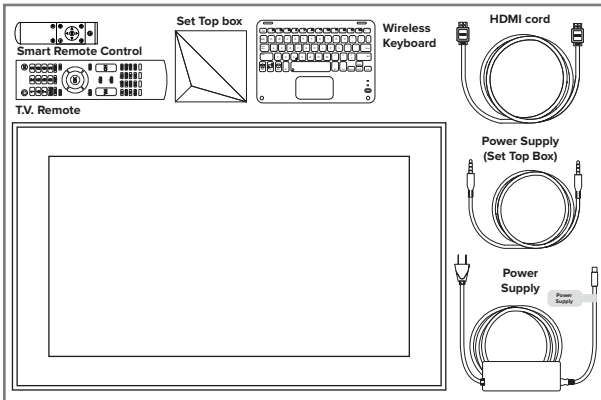

1 Check the items after receiving

Before installing, check to ensure that you have received all the package contents.

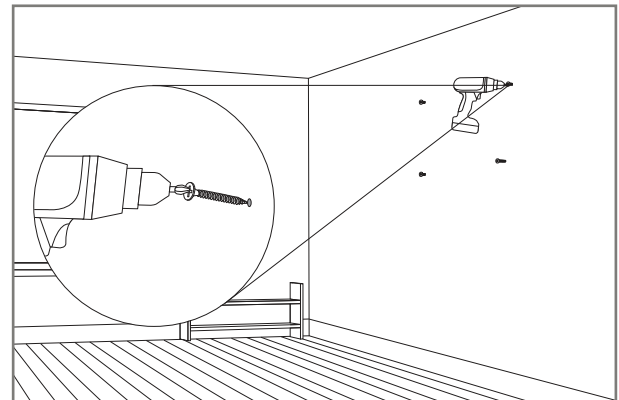

2 Install four screws to the wall.

Ensure the wall is correctly prepared for installation. Determine the type of screws or bolts needed for the wall surface you are installing to. Drill holes into the wall and install four screws in.

(Note: It is the installer's responsibility that all electrical, audio/visual, and framing construction is code compliant.)

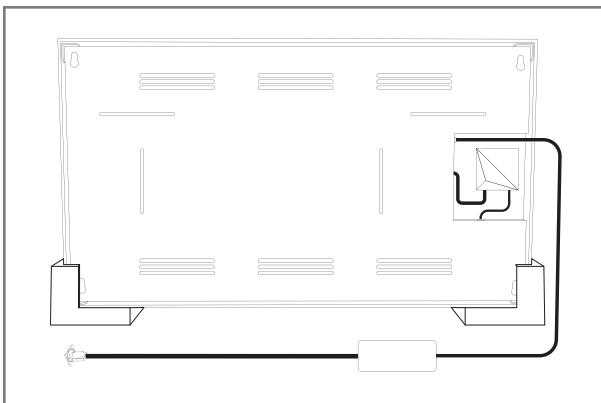

3 Attach the power cord

Lay the Spectrum T.V. on a padded surface to connect the power cord.

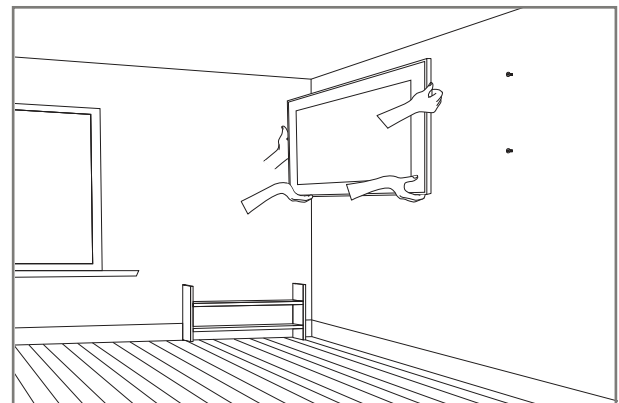

4 Hang TV

Carefully lift the T.V. and securely engage the four holes in the corners of the mirror to the screws installed on the wall.

(Note: It is recommended that 2 or more people assist in the installation of this mirror.)

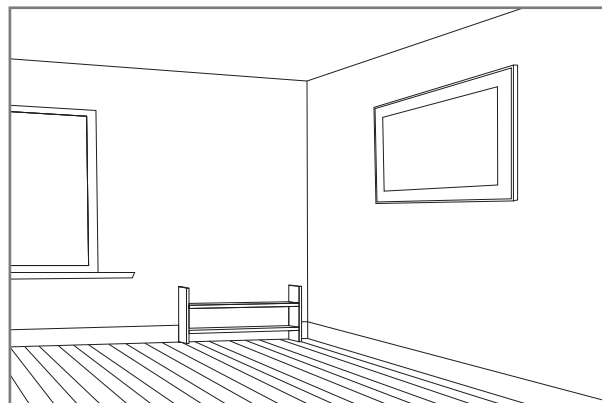

5 Finished.

Enjoy your new Spectrum T.V.

Spectrum T.V.



Initial Set up

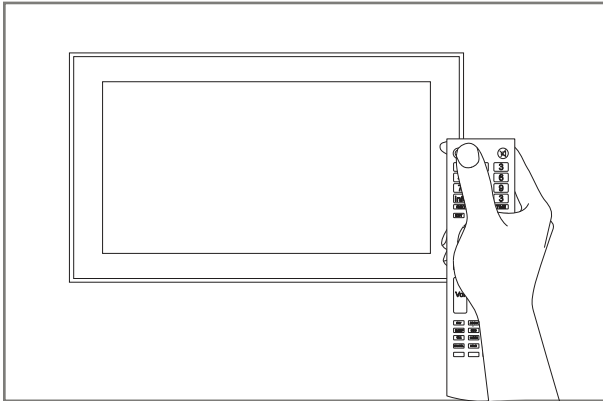

1 Turn the T.V. on

Turn the T.V. on by pressing the power button on the T.V. remote control.

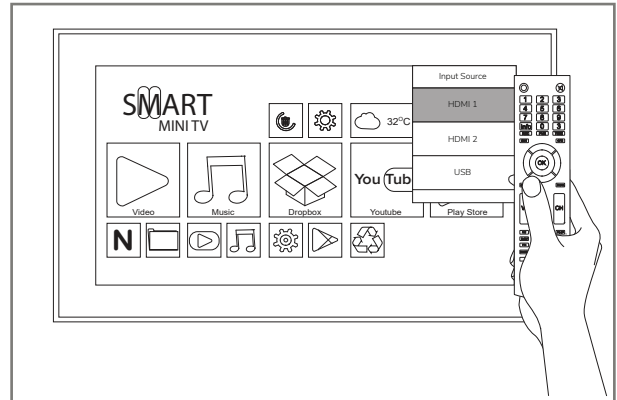

2 Press Source

Press the source button on the remote. On the small source input settings that would pop up, choose and press HDMI 1.

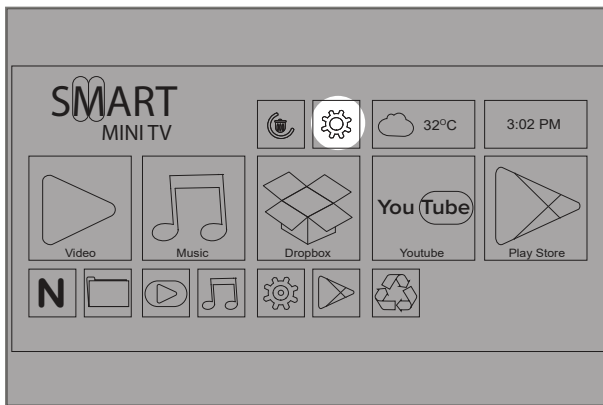

3 Connect to Wifi

Press the settings icon and connect to the internet.

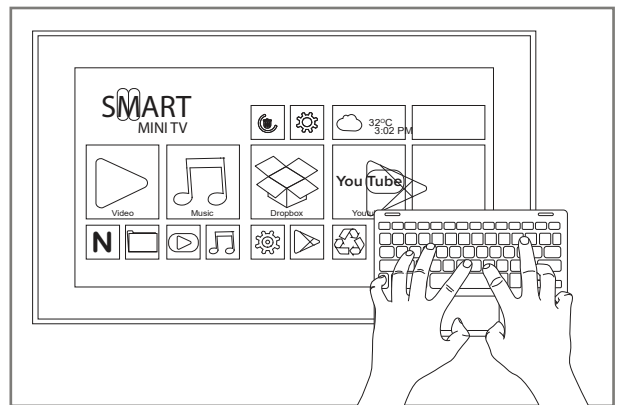

4 Control and manage apps

Use the keyboard to navigate through the spectrum and customize your T.V.

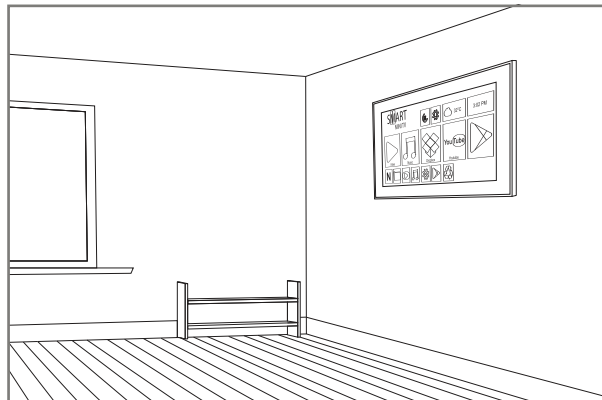

5 Done.

All set. The spectrum T.V. is ready to use.

App Installation

Option 1: Download from google store

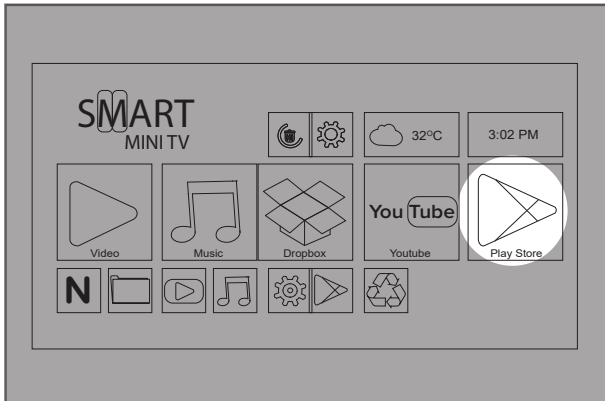

1 Google Play Store

Go to Google Play Store.

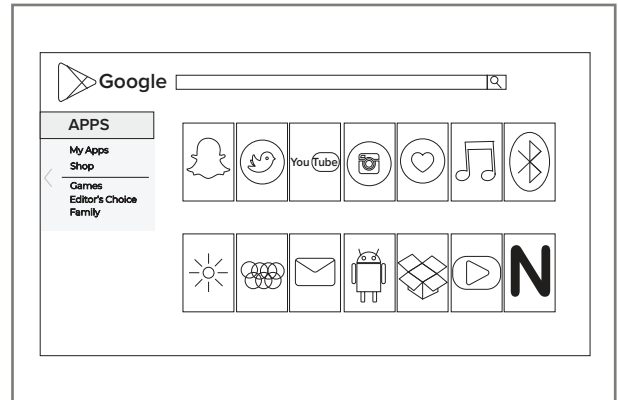

2 Search

Search for the app you wish to install.

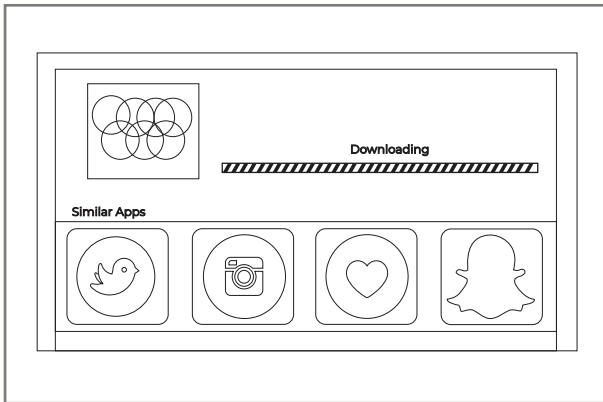

3 Install

Click install and wait for it to finish downloading.

Option 2: Download APK

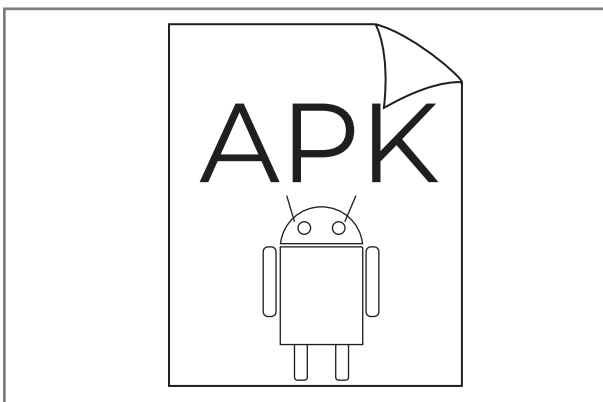

1 Find and download

Find and download the APK of your desired application online.

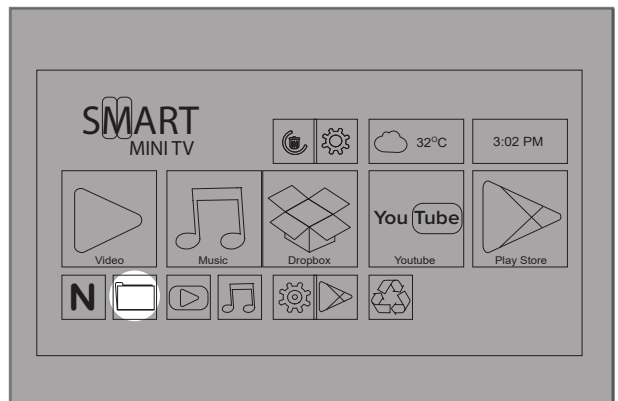

2 Install

Once the download is complete. Go to file manager and find the APK you downloaded. Click it and it will be installed.

Keyboard

Parts and Manual

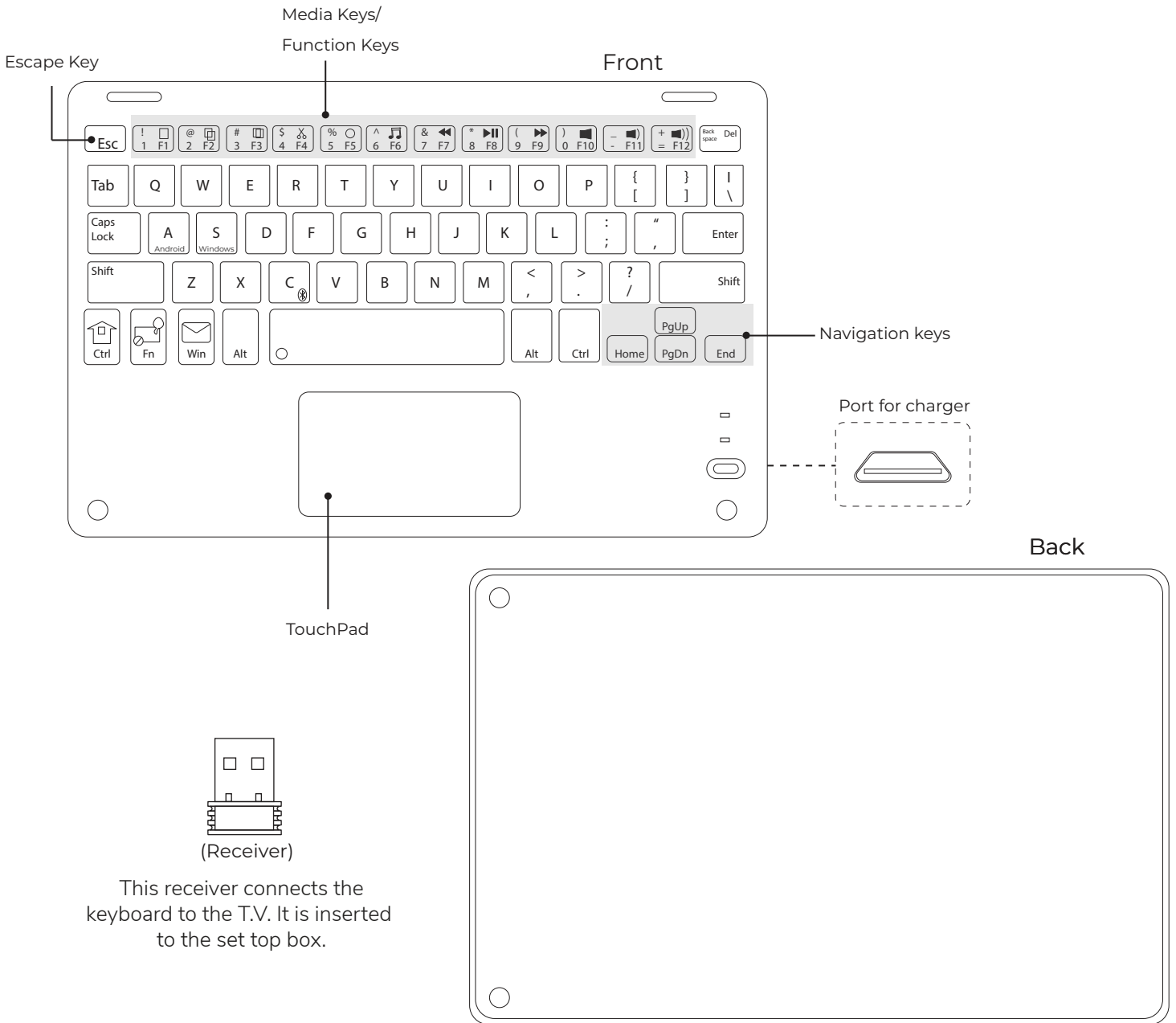

 The keyboard is rechargeable.

 In the event that the remote is lost, the keyboard can perform most remote functions.

Smart Remote Control

Parts and Manual

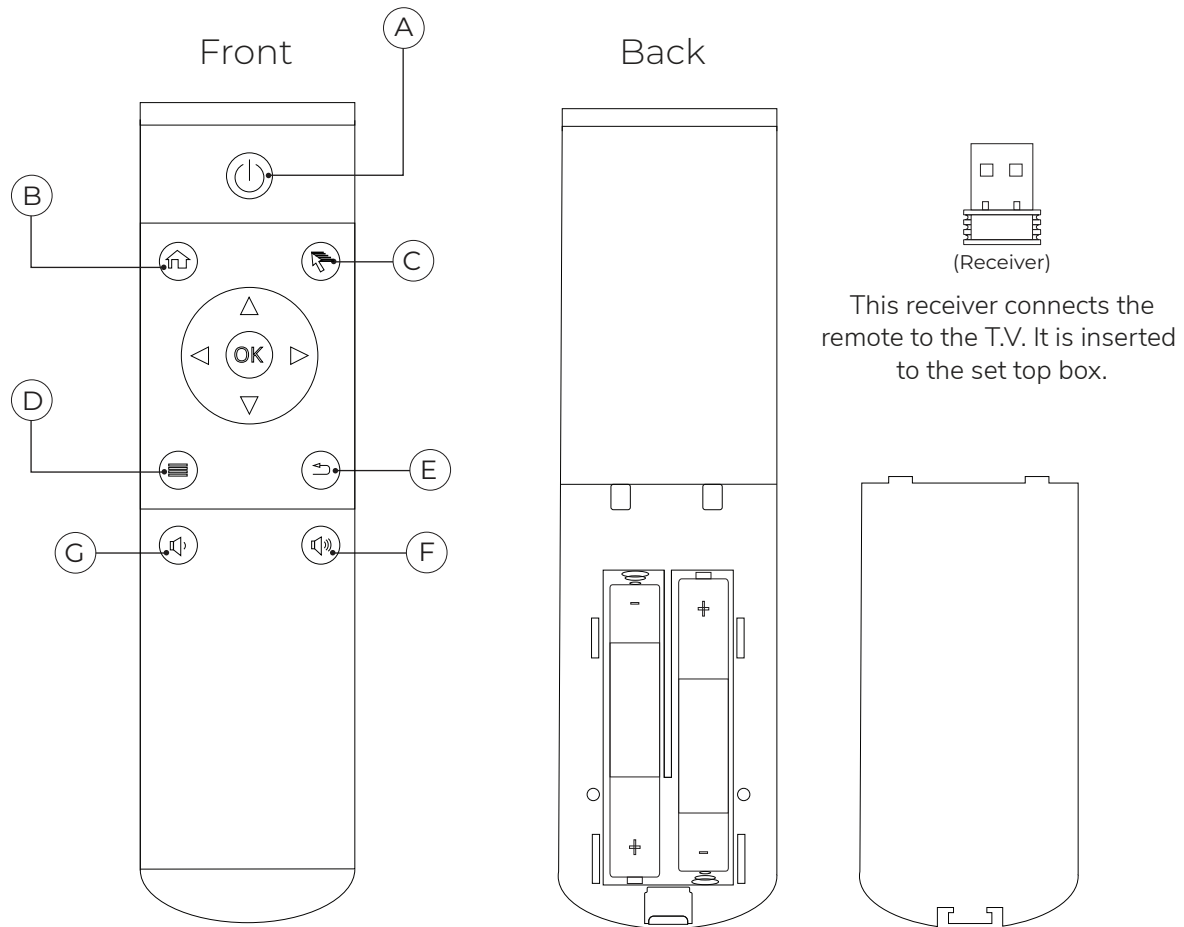

Insert two AAA batteries at the back of the remote.
(Battery not included)

Buttons:

A		Power Button
B		Press this to go back to main screen.
C		Press this button to point and click on the screen.
D		Press this to bring up the T.V. Settings.
E		Press this to go back to the page that was previously displayed.
F		Press this to raise the volume up.
F		Press this to lower the volume down.

T.V. Remote

Parts and manual

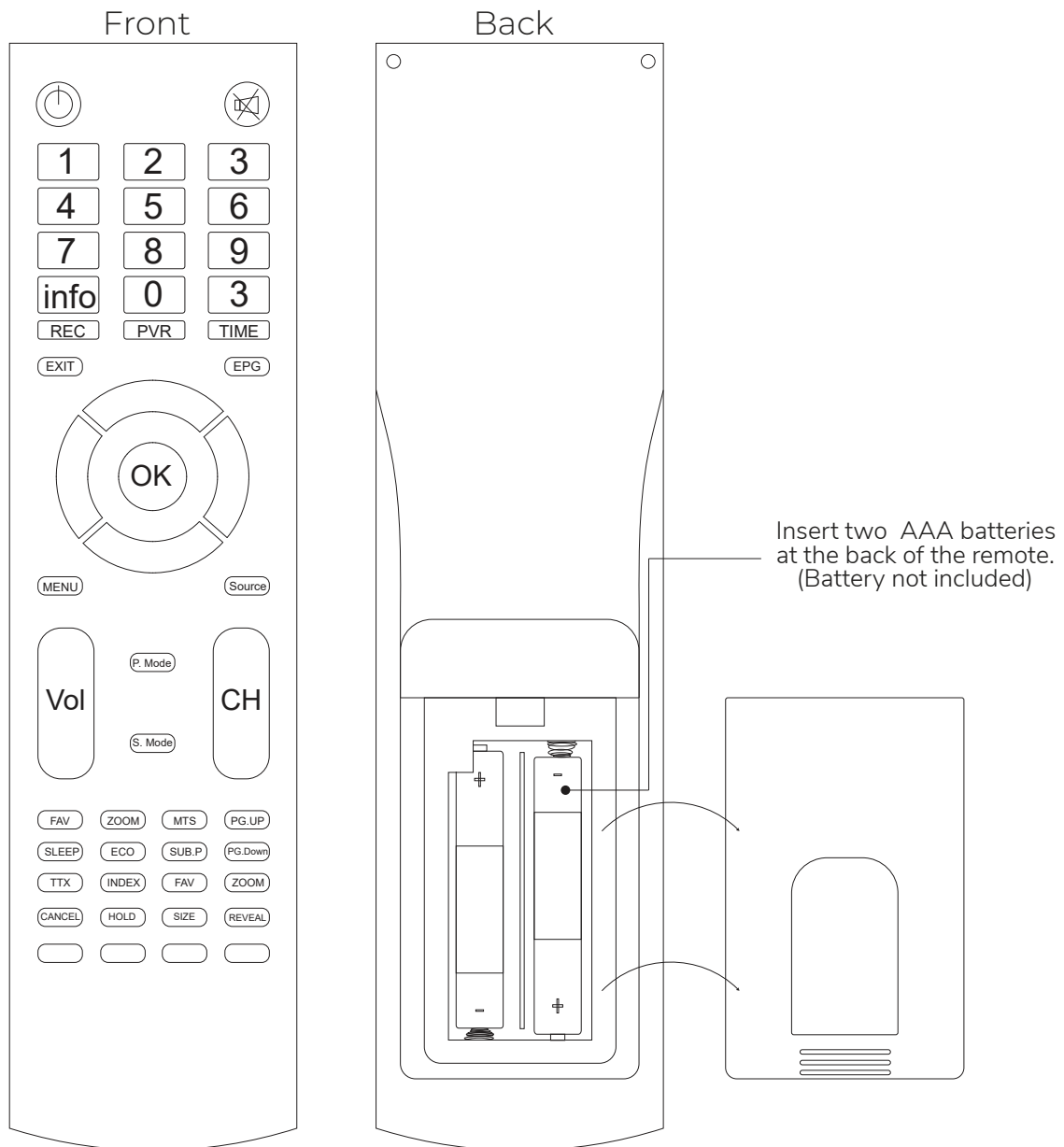

What could you do with this remote?

- Change the brightness and color of the screen
- Change the HDMI input
- Increase the audio volume of the T.V.
- several more advanced settings